

ILL-P9541K2



2 Fold
(81x81x12.8mm)

COLOR -

FEATURES

- Configurable Bicolored LED Indicator for Each Button
- Extensive Operating Functions
- Switching and Dimming Function
- Scene Recall and Storage Function
- Roller Blinds and Shutter Function
- Push Buttons can be adjusted for 1 or 2 button operation
- Powered by KNX Bus Power Supply

SAFETY & WARNINGS

- DO NOT installed with power applied to device.
- DO NOT expose the device to moisture.

SPECIFICATIONS

Number of Rockers	2
Number of bicolored LED	2
Orientation LED	1
KNX busconnection terminal	0.8mm Φ, single core
Power Supply	KNX Bus
Power Consumption KNX bus typ.	<0.3W
Operation temperature range	0 bis + 45 °C
Waterproof Grade	IP 20
Dimensions(W x H x D)	55.6 x 55.6 x 12.3 mm

OPERATION

The KNX Push Button releases KNX telegrams after pushing the buttons, 1 or 2 Button(the top two buttons) operation can be parameterized. The device provides extensive functions that are freely configurable with ETS4 software to any push buttons. The push button contains 8 buttons, which can be parameterized individually. The bus can be connected at the back of the push buttons. Linked working mode (2 button operation, left and right) or independent working mode (1 button operation, left or right) can be set for the buttons.

DIAMENSIONS

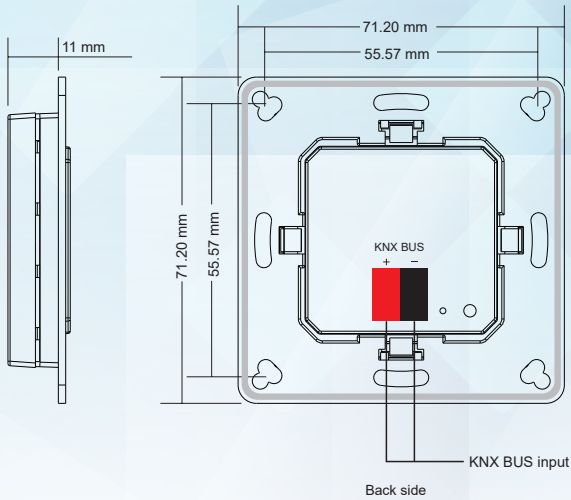

INSTALLATION

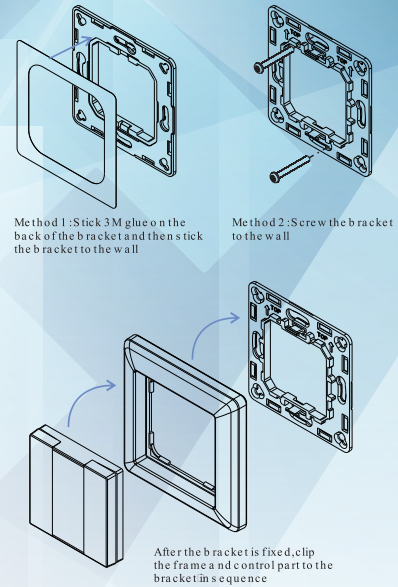

WIRING DIAGRAM

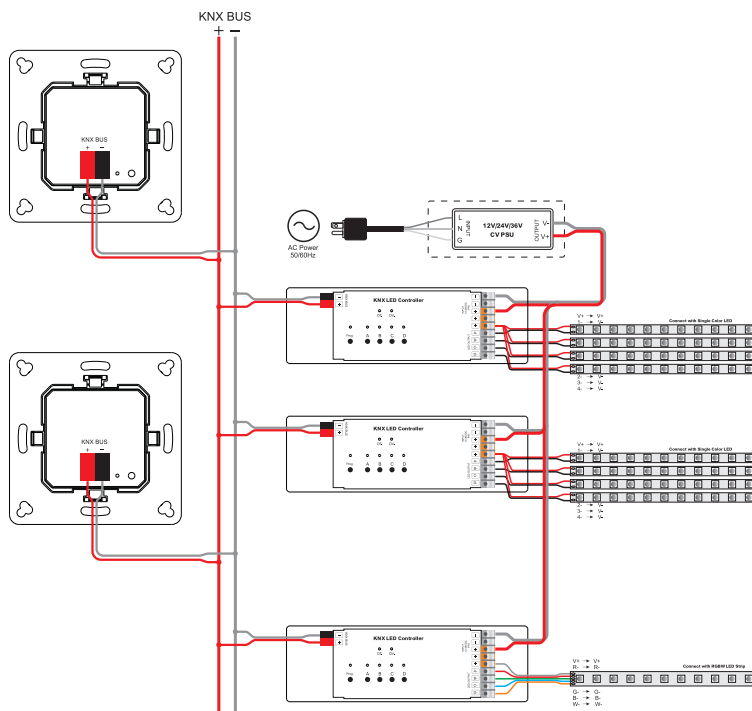

The key part of this controller is a universal, extremely rotary standard switch element that can be integrated in numerous frames by different manufactures as below list:

BEKER	S1, B1, B3, B7 glass
GIRA	Standard55, E2, Event, Esprit
JUNG	A500, Aplus
MERTEN	M-smart, M-Arc, M-Plan